

http://allthumbsdiy.com/outdoor-power-equipment/fast-and-easy-fix-for-your-generac-wheelhouse-5500-5550-portable-generator



WheelHouse™ 5550 RATED WATTS

PORTABLE GENERATOR

Owner's Manual

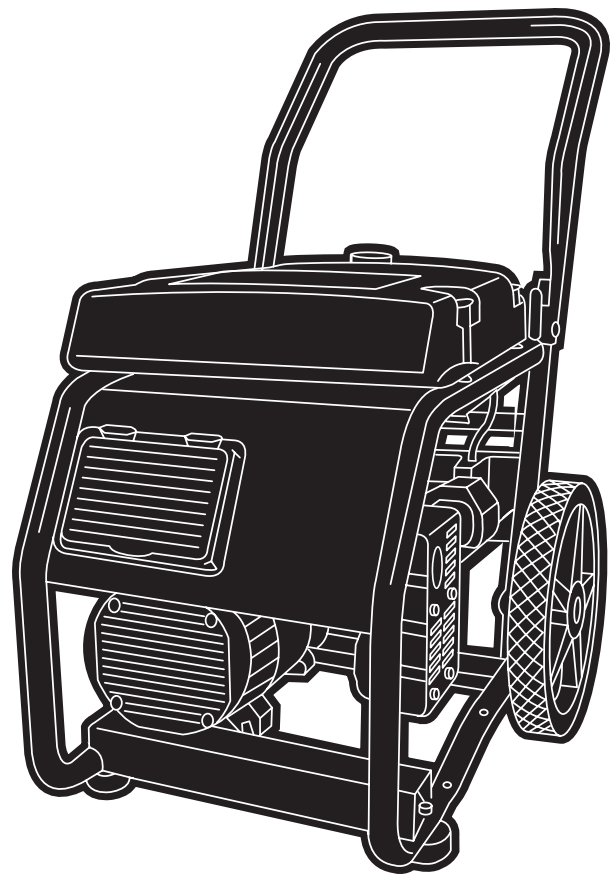

Parts Included*

- Generator
- Wheel kit
- Locking 30 Amp plug
- Engine oil
- Two packets of fuel stabilizer
- Owner's manual
- Engine manual

*If any parts are missing or damaged, call 1-800-270-1408.

Table of Contents

Safety Rules.....	2-4
Know Your Generator.....	5
Assembly.....	6-7
Operation.....	8-11
Product Specifications.....	12
Maintenance.....	12
Storage.....	13
Troubleshooting.....	14
Notes.....	15
Warranty.....	Last Page

Questions? Help is just a moment away!

Call: **Generac Generator Helpline - 1-800-270-1408** M-F 8-5 CT
Web: www.generac-portables.com or www.briggsandstratton.com



http://allthumbsdiy.com/outdoor-power-equipment/fast-and-easy-fix-for-your-generac-wheelhouse-5500-5550-portable-generator



WheelHouse™ 5550 Watt Generator



EQUIPMENT DESCRIPTION



Read this manual carefully and become familiar with your generator. Know its applications, its limitations and any hazards involved.

The generators are an engine-driven, revolving field, alternating current (AC) generator. It was designed to supply electrical power for operating compatible electrical lighting, appliances, tools and motor loads. The generator's revolving field is driven at about 3,600 rpm by a single-cylinder engine.

CAUTION! DO NOT exceed the generator's wattage/ampere capacity. See "Don't Overload Generator".

Every effort has been made to ensure that information in this manual is accurate and current. However, we reserve the right to change, alter or otherwise improve the product and this document at any time without prior notice.

The Emission Control System for this generator is warranted for standards set by the Environmental Protection Agency. For warranty information refer to the engine owner's manual.

SAFETY RULES



This is the safety alert symbol. It is used to alert you to potential personal injury hazards. Obey all safety messages that follow this symbol to avoid possible injury or death.

The safety alert symbol (▲) is used with a signal word (DANGER, CAUTION, WARNING), a pictorial and/or a safety message to alert you to hazards. **DANGER** indicates a hazard which, if not avoided, will result in death or serious injury. **WARNING** indicates a hazard which, if not avoided, could result in death or serious injury. **CAUTION** indicates a hazard which, if not avoided, might result in minor or moderate injury. **CAUTION**, when used without the alert symbol, indicates a situation that could result in equipment damage. Follow safety messages to avoid or reduce the risk of injury or death.



WARNING

The engine exhaust from this product contains chemicals known to the State of California to cause cancer, birth defects, or other reproductive harm.

Hazard Symbols and Meanings

Electrocution	Electrical Shock	Electrical Shock
Explosion	Fire	
Toxic Fumes	Kickback	Hot Surface



WheelHouse™ 5550 Watt Generator



WARNING



Running generator gives off carbon monoxide, an odorless, colorless, poison gas. Breathing carbon monoxide will cause nausea, fainting or death.

- Operate generator **ONLY** outdoors.
- Keep exhaust gas from entering a confined area through windows, doors, ventilation intakes or other openings.
- **DO NOT** operate generator inside any building or enclosure, including the generator compartment of a recreational vehicle (RV).

WARNING



Generator produces powerful voltage. Failure to isolate generator from power utility can result in death or injury to electric utility workers due to backfeed of electrical energy.

- When using generator for backup power, notify utility company. Use approved transfer equipment to isolate generator from electric utility.
- Use a ground circuit fault interrupter (GFCI) in any damp or highly conductive area, such as metal decking or steel work.
- **DO NOT** touch bare wires or receptacles.
- **DO NOT** use generator with electrical cords which are worn, frayed, bare or otherwise damaged.
- **DO NOT** operate generator in the rain.
- **DO NOT** handle generator or electrical cords while standing in water, while barefoot, or while hands or feet are wet.
- **DO NOT** allow unqualified persons or children to operate or service generator.

WARNING



Rapid retraction of starter cord (kickback) will pull hand and arm toward engine faster than you can let go. Broken bones, fractures, bruises or sprains could result.

- When starting engine, pull cord slowly until resistance is felt and then pull rapidly to avoid kickback.
- **NEVER** start or stop engine with electrical devices plugged in and turned on.

WARNING



Fuel and its vapors are extremely flammable and explosive.



Fire or explosion can cause severe burns or death.

WHEN ADDING OR DRAINING FUEL

- Turn generator **OFF** and let it cool at least 2 minutes before removing fuel cap. Loosen cap slowly to relieve pressure in tank.
- Fill or drain fuel tank outdoors.
- **DO NOT** overfill tank. Allow space for fuel expansion.
- Keep fuel away from sparks, open flames, pilot lights, heat, and other ignition sources.
- **DO NOT** light a cigarette or smoke.

WHEN STARTING EQUIPMENT

- Ensure spark plug, muffler, fuel cap and air cleaner are in place.
- **DO NOT** crank engine with spark plug removed.
- If fuel spills, wait until it evaporates before starting engine.

WHEN OPERATING EQUIPMENT

- Do not tip engine or equipment at angle which causes fuel to spill.
- This generator is not for use in mobile equipment or marine applications.

WHEN TRANSPORTING OR REPAIRING EQUIPMENT

- Transport/repair with fuel tank **EMPTY** or with fuel shutoff valve **OFF**.
- Disconnect spark plug wire.

WHEN STORING FUEL OR EQUIPMENT WITH FUEL IN TANK

- Store away from furnaces, stoves, water heaters, clothes dryers or other appliances that have pilot light or other ignition source because they can ignite fuel vapors.



WARNING



- This generator does not meet U. S. Coast Guard Regulation 33CFR-183 and should not be used on marine applications.
- Failure to use the appropriate U. S. Coast Guard approved generator could result in bodily injury and/or property damage.



WheelHouse™ 5550 Watt Generator



 WARNING	
	Unintentional sparking can result in fire or electric shock.
	
WHEN ADJUSTING OR MAKING REPAIRS TO YOUR GENERATOR	
<ul style="list-style-type: none">• Disconnect the spark plug wire from the spark plug and place the wire where it cannot contact spark plug.	
WHEN TESTING FOR ENGINE SPARK	
<ul style="list-style-type: none">• Use approved spark plug tester.• DO NOT check for spark with spark plug removed.	

 WARNING	
	Running engines produce heat. Temperature of muffler and nearby areas can reach or exceed 150°F (65°C).
	Severe burns can occur on contact. Combustible debris, such as leaves, grass, brush, ect. can catch fire.
<ul style="list-style-type: none">• DO NOT touch hot surfaces.• Allow equipment to cool before touching.• The generator must be at least 5 feet from structures having combustible walls and/or other combustible materials.• Keep at least 3 feet of clearance on all sides of generator for adequate cooling, maintenance and servicing.• In the State of California a spark arrester is required by law (Section 4442 of the California Public Resources Code). Other states may have similar laws. Federal laws apply on federal lands. If you equip the muffler with a spark arrester, it must be maintained in effective working order.	

 CAUTION	
Excessively high operating speeds increase risk of injury and damage to generator. Excessively low speeds impose a heavy load.	
<ul style="list-style-type: none">• DO NOT tamper with governed speed. Generator supplies correct rated frequency and voltage when running at governed speed.• DO NOT modify generator in any way.	

CAUTION	
Exceeding generators wattage/amperage capacity can damage generator and/or electrical devices connected to it.	
<ul style="list-style-type: none">• See "Don't Overload Generator".• Start generator and let engine stabilize before connecting electrical loads.• Connect electrical loads in OFF position, then turn ON for operation.• Turn electrical loads OFF and disconnect from generator before stopping generator.	

CAUTION	
Improper treatment of generator can damage it and shorten its life.	
<ul style="list-style-type: none">• Use generator only for intended uses.• If you have questions about intended use, ask dealer or call the Generac generator helpline at 1-800-270-1408.• Operate generator only on level surfaces.• DO NOT expose generator to excessive moisture, dust, dirt, or corrosive vapors.• DO NOT insert any objects through cooling slots.• If connected devices overheat, turn them off and disconnect them from generator.• Shut off generator if:<ul style="list-style-type: none">-electrical output is lost;-equipment sparks, smokes, or emits flames;-unit vibrates excessively.	



KNOW YOUR GENERATOR

Read this owner's manual and safety rules before operating your generator.

Compare the illustrations with your generator, to familiarize yourself with the locations of various controls and adjustments. Save this manual for future reference.

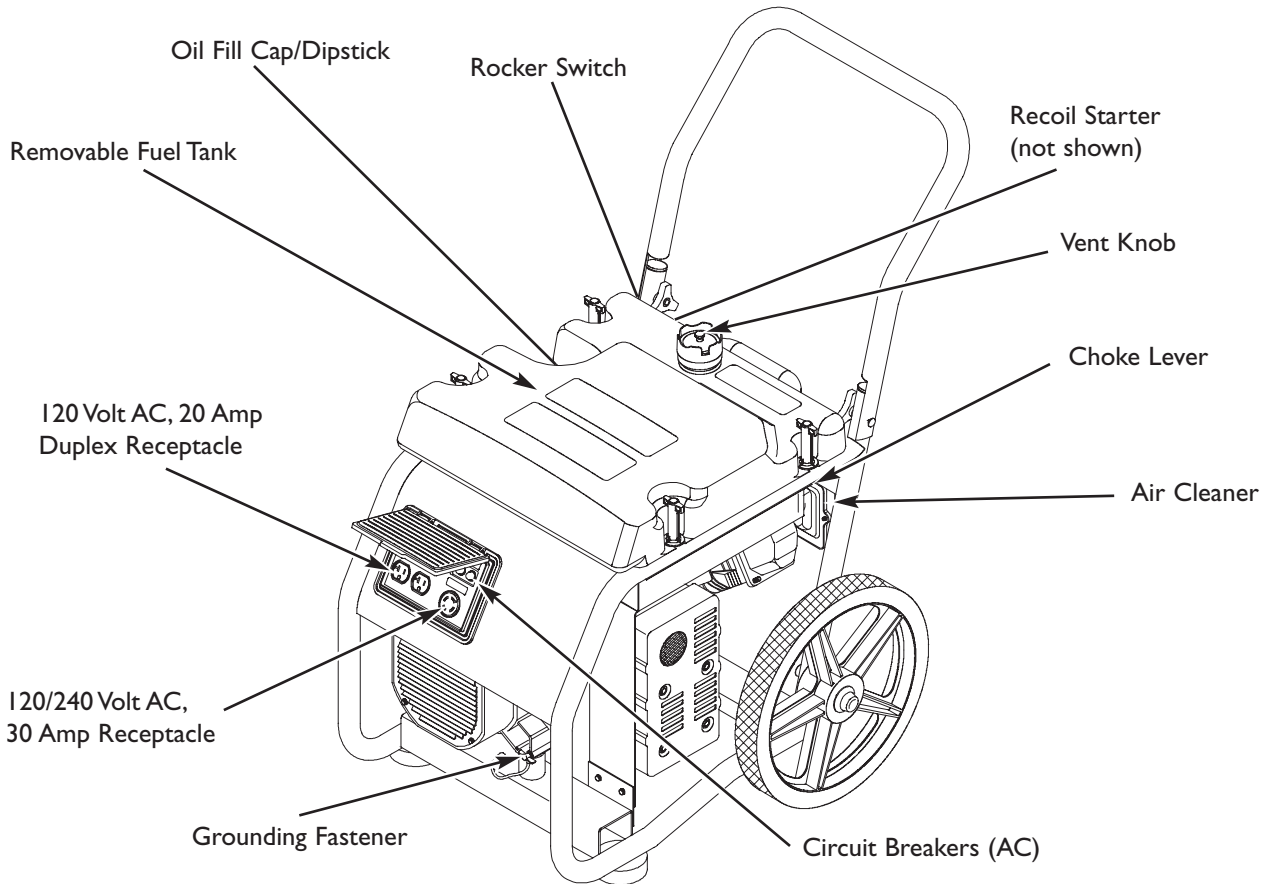

120 Volt AC, 20 Amp, Duplex Receptacle — May be used to supply electrical power for the operation of 120 Volt AC, 20 Amp, single phase, 60 Hz electrical lighting, appliance, tool and motor loads.

120/240 Volt AC, 30 Amp Locking Receptacle — May be used to supply electrical power for the operation of 120 and/or 240 Volt AC, 30 Amp, single phase, 60 Hz electrical lighting, appliance, tool and motor loads.

Air Cleaner — Protects engine by filtering dust and debris out of intake air.

Choke Lever — Used when starting a cold engine.

Circuit Breakers (AC) — Each receptacle is provided with a "push to reset" circuit breaker to protect the generator against electrical overload.

Removable Fuel Tank — Capacity of five (5) U.S. gallons. Easily removed for convenient refueling.

Grounding Fastener — If required, please consult a qualified electrician, electrical inspector, or local agency having jurisdiction.

Oil Fill Cap/Dipstick — Check and add oil to engine here.

Recoil starter — Used to start the engine.

Rocker Switch — Set this switch to "On" before using recoil starter. Set switch to "Off" to switch OFF engine.

Vent Knob — Must be open when generator is running.

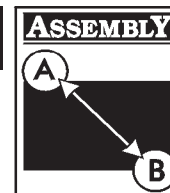

ASSEMBLY

Your generator requires some assembly and is ready for use after it has been properly serviced with the recommended oil and fuel. If you have any problems with the assembly of your generator, please call the generator helpline at **1-800-270-1408**.

Remove Generator From Carton

- Set the carton on a rigid flat surface with “This Side Up” arrows pointing upward.
- Carefully open the top flaps of the shipping carton.
- Cut carton corners from top to bottom at end of carton near wheels. Lay that side of carton down flat.
- Remove all packing material, carton fillers, etc.
- Roll the generator out of the shipping carton.

BEFORE STARTING THE ENGINE

Secure Handle

Secure the handle using the following steps:

- Loosen knobs of the handle.
- Raise the handle.
- Insert handle pins, if equipped (P/N B4135GS).
- Hand tighten knobs.

Add Engine Oil

- Place generator on a level surface.
- Use a long neck funnel OR remove the fuel tank as described in “Fuel Tank”, when adding or changing oil.

CAUTION

Any attempt to crank or start the engine before it has been properly filled with the recommended oil will result in equipment failure.

- Refer to engine manual for oil fill information.
- Damage to equipment resulting from failure to follow this instruction will void warranty.

- Refer to engine owner’s manual and follow oil recommendations and instructions.

NOTE: Check oil often during engine break-in. Refer to engine owner’s manual for recommendations.

NOTE: The generator assembly rotates on a prelubricated and sealed ball bearing that requires no additional lubrication for the life of the bearing.

Add Fuel

NOTE: This gasoline engine is certified to operate on gasoline. Exhaust Emission Control System: EM (Engine Modifications).

WARNING

- Fuel and its vapors are extremely flammable and explosive.
- Fire or explosion can cause severe burns or death.

WHEN ADDING FUEL

- Turn generator OFF and let it cool at least 2 minutes before removing fuel cap. Loosen cap slowly to relieve pressure in tank.
- Fill fuel tank outdoors.
- DO NOT overfill tank. Allow space for fuel expansion.
- Keep fuel away from sparks, open flames, pilot lights, heat, and other ignition sources.
- DO NOT light a cigarette or smoke.

1. Use clean, fresh, regular UNLEADED fuel with a minimum of 85 octane. DO NOT use fuel which contains Methanol. DO NOT mix oil with fuel.
2. Clean area around fuel fill cap, remove cap.
3. Slowly add regular unleaded fuel to fuel tank. Be careful not to overfill. Allow about 1.5" of tank space for fuel expansion (Figure 1).

Figure 1 - Fuel Expansion

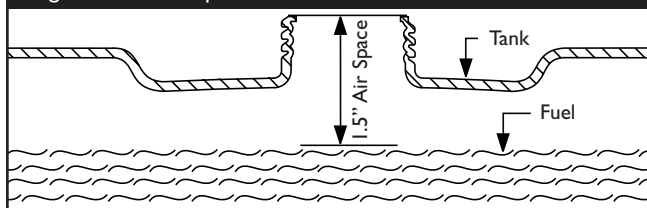

4. Install fuel cap and wipe up any spilled fuel.

Fuel Tank

As is common with all plastic fuel containers, the removable fuel tank supplied with this generator may swell or expand due to build-up of fuel vapors when the vent knob is closed. This tank is designed and has been tested to safely withstand pressure-buildup. The 'ballooning' condition

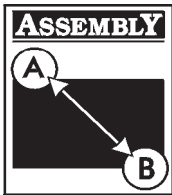

is relieved by turning the vent knob fully counterclockwise or loosening and retightening the fuel cap/gauge. When installing the tank on your generator, relieve tank pressure before tightening the four large plastic wing nuts.

IMPORTANT: The vent knob should be closed whenever you move the generator or transport the fuel tank.

- 1. Turn the vent knob fully clockwise on the fuel gauge to close it (Figure 2).

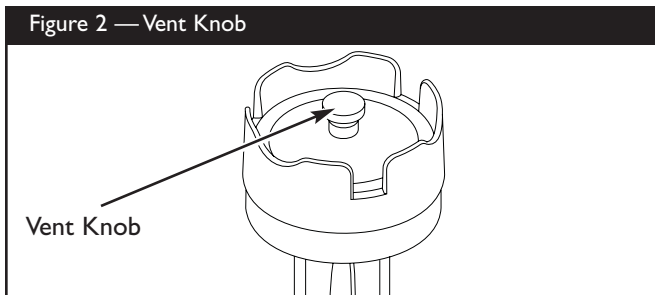

WARNING! Failure to follow these fuel tank removal instructions could result in death or serious injury.

- 2. Turn the fuel shut off valve to the “Off” position (Figure 3).

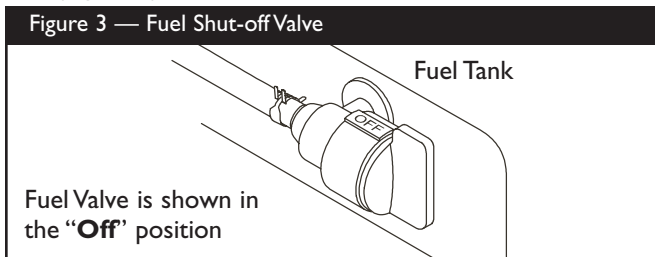

- 3. Disconnect the quick connect on the fuel line by pushing on the metal tab and twisting apart (Figure 4). Release the metal tab. Some fuel that is left in the line will spill out.

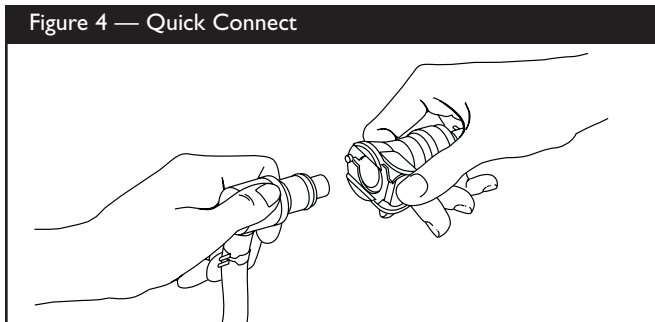

- 4. Remove the four large plastic wing nuts holding the tank onto the frame by turning them counterclockwise (Figure 5).

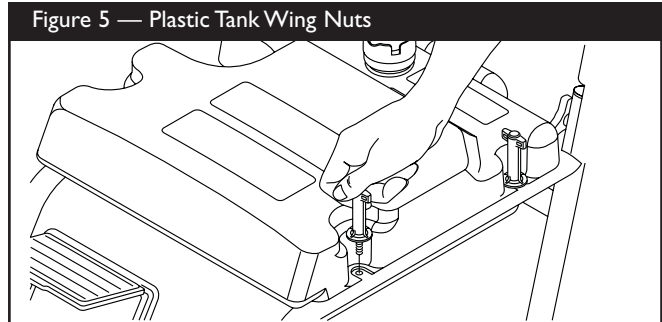

- 5. Lift off the fuel tank by grasping the handle (provided on the tank) with one hand and putting the other hand in the finger pocket (Figure 6). Lift the tank straight up.

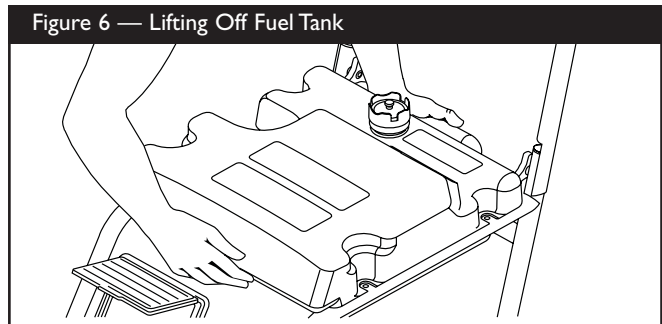

IMPORTANT: The fuel tank MUST be filled with it lying flat, not slanted or standing upright (Figure 7). DO NOT let the fuel valve and quick connect come in contact with any dirt.

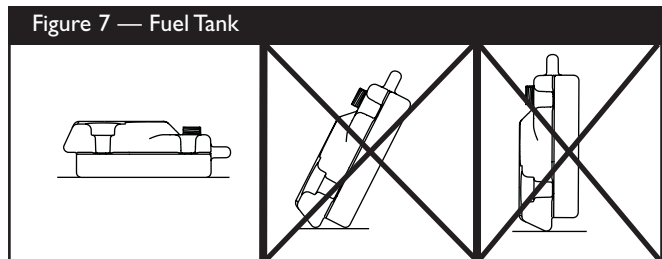

To place the fuel tank back on the unit, follow these same steps in reverse order. Make sure the four large plastic wing nuts are tightened securely.

IMPORTANT: Remove any dirt found inside the quick connect before putting the fuel tank back on the unit. **Make sure the vent knob is turned fully counterclockwise to open it.** If you don't open it, fuel will not flow into the fuel line causing the unit to not start.



USING THE GENERATOR

System Ground

The generator has a system ground that connects the generator frame components to the ground terminals on the AC output receptacles. The system ground is connected to the AC neutral wire (see “Equipment Description”, earlier in this manual).

Special Requirements

There may be Federal or State Occupational Safety and Health Administration (OSHA) regulations, local codes, or ordinances that apply to the intended use of the generator. Please consult a qualified electrician, electrical inspector, or the local agency having jurisdiction.

- In some areas, generators are required to be registered with local utility companies.
- If the generator is used at a construction site, there may be additional regulations which must be observed.

Connecting to a Building’s Electrical System

Connections for standby power to a building’s electrical system must be made by a qualified electrician. The connection must isolate the generator power from utility power, and must comply with all applicable laws and electrical codes.

	WARNING
Generator produces powerful voltage. Failure to isolate generator from power utility can result in death or injury to electric utility workers due to backfeed of electrical energy.	
<ul style="list-style-type: none"> • When using generator for backup power, notify utility company. Use approved transfer equipment to isolate generator from electric utility. • Use a ground fault circuit interrupter (GFCI) in any damp or highly conductive area, such as metal decking or steel work. • DO NOT touch bare wires or receptacles. • DO NOT use generator with electrical cords which are worn, frayed, bare or otherwise damaged. • DO NOT operate generator in the rain. • DO NOT handle generator or electrical cords while standing in water, while barefoot, or while hands or feet are wet. • DO NOT allow unqualified persons or children to operate or service generator. 	

Generator Location

Generator Clearance

WARNING	
	Running generator gives off carbon monoxide, an odorless, colorless, poison gas. Breathing carbon monoxide will cause nausea, fainting or death.
<ul style="list-style-type: none"> • Operate generator ONLY outdoors. • Keep exhaust gas from entering a confined area through windows, doors, ventilation intakes or other openings. • DO NOT operate generator inside any building or enclosure, including the generator compartment of a recreational vehicle (RV). 	

The generator must be at least 5 ft. (152 cm) from structures having combustible walls and/or other combustible materials. Leave at least 3 ft. (92 cm) all around generator including overhead, for adequate cooling, maintenance and servicing.

Place generator in a well ventilated area, which will allow for removal of deadly exhaust gas. DO NOT place generator where exhaust gas could accumulate and enter inside or be drawn into a potentially occupied building. Ensure exhaust gas is kept away from any windows, doors, ventilation intakes or other openings that can allow exhaust gas to collect in a confined area (Figure 8). Prevailing winds and air currents should be taken into consideration when positioning generator.

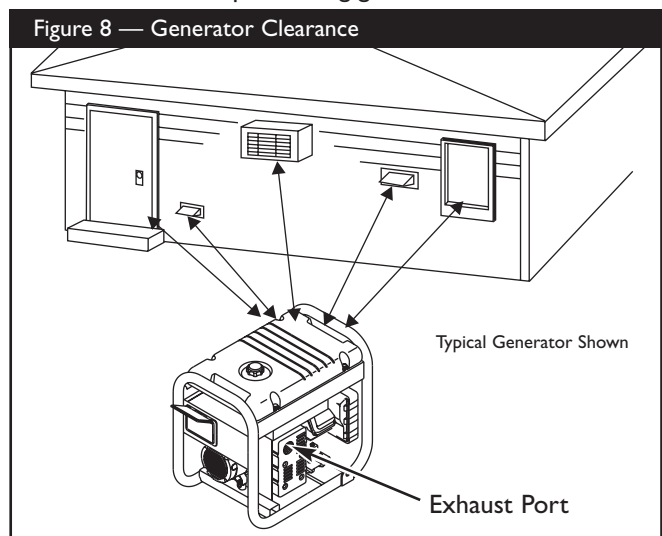



OPERATING THE GENERATOR

CAUTION

Exceeding generators wattage/amperage capacity can damage generator and/or electrical devices connected to it.

- See “Don’t Overload Generator”.
- Start generator and let engine stabilize before connecting electrical loads.
- Connect electrical loads in OFF position, then turn ON for operation.
- Turn electrical loads OFF and disconnect from generator before stopping generator.

Starting the Engine

Disconnect all electrical loads from the generator. Follow these start instruction steps in numerical order:

1. Make sure unit is on a level surface.

IMPORTANT: Failure to start and operate unit on a level surface will cause the unit not to start or shut down during operation.

2. Make sure the fuel line quick connect is hooked up and that all four tank hold-downs are firmly tight.
3. Turn the vent knob fully counter-clockwise. See Figure 2 on page 7.
4. Rotate the fuel valve to the “On” position. See Figure 3 on page 7.
5. Start the engine according to instructions given in the engine owner’s manual.

WARNING



Rapid retraction of starter cord (kickback) will pull hand and arm toward engine faster than you can let go. Broken bones, fractures, bruises or sprains could result.

- When starting engine, pull cord slowly until resistance is felt and then pull rapidly to avoid kickback.
- NEVER start or stop engine with electrical devices plugged in and turned on.

NOTE: If engine starts after 3 pulls but fails to run, or if unit shuts down during operation, make sure unit is on a level surface and check for proper oil level in crankcase. This unit may be equipped with a low oil protection device. See engine manual.

WARNING



Running engines produce heat. Temperature of muffler and nearby areas can reach or exceed 150°F (65°C).



Severe burns can occur on contact. Combustible debris, such as leaves, grass, brush, ect. can catch fire.

- DO NOT touch hot surfaces.
- Allow equipment to cool before touching.
- The generator must be at least 5 feet from structures having combustible walls and/or other combustible materials.
- Keep at least 3 feet of clearance on all sides of generator for adequate cooling, maintenance and servicing.
- In the State of California a spark arrester is required by law (Section 4442 of the California Public Resources Code). Other states may have similar laws. Federal laws apply on federal lands. If you equip the muffler with a spark arrester, it must be maintained in effective working order.

Connecting Electrical Loads

- Let engine stabilize and warm up for a few minutes after starting.
- Plug in and turn on the desired 120 and/or 240 Volt AC, single phase, 60 Hz electrical loads.
- DO NOT connect 240 Volt loads to the 120 Volt receptacles.
- DO NOT connect 3-phase loads to the generator.
- DO NOT connect 50 Hz loads to the generator.
- **DO NOT OVERLOAD THE GENERATOR.** See “Don’t Overload Generator”.

Stopping the Engine

1. Unplug **all** electrical loads from generator panel receptacles. NEVER start or stop engine with electrical devices plugged in and turned on.
2. Let engine run at no-load for 30 seconds to stabilize internal temperatures of engine and alternator.
3. Turn engine off according to instructions given in engine owner’s manual.
4. Move fuel valve to “Off” position.

RECEPTACLES

⚠ CAUTION

Receptacles may be marked with rating value greater than generator output capacity.

- NEVER attempt to power a device requiring more amperage than generator or receptacle can supply.
- DO NOT overload the generator. See “Don’t Overload Generator”.

120 Volt AC, 20 Amp, Duplex Receptacle

Each receptacle (Figure 9) is protected against overload by a push-to-reset circuit breaker.

Figure 9 — 120 Volt AC, 20 Amp Duplex Receptacle

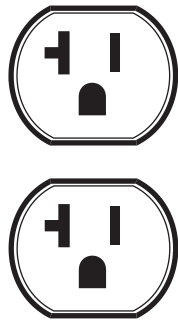

Use each receptacle to operate 120 Volt AC, single-phase, 60 Hz electrical loads requiring up to 2,400 watts (2.4 kW) at 20 Amps of current. Use cord sets that are rated for 125 Volt AC loads at 20 Amps (or greater).

120/240 Volt AC, 30 Amp, Locking Receptacle

Use a NEMA L14-30 plug with this receptacle. Connect a 4-wire cord set rated for 250 Volt AC loads at 30 Amps (or greater) (Figure 10). You can use the same 4-wire cord if you plan to run a 120 Volt load.

Figure 10 — 120/240 Volt AC, 30 Amp Receptacle

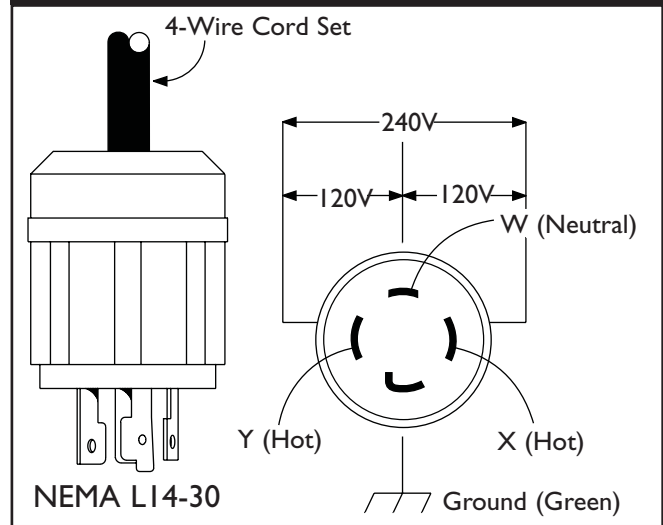

This receptacle powers 120/240 Volt AC, 60 Hz, single phase loads requiring up to 2,775 watts of power at 23.1 Amps for 120 Volts; 5,550 watts of power (5.55 kW) at 23.1 Amps for 240 Volts. The outlet is protected by a push-to-reset circuit breaker.



DON'T OVERLOAD GENERATOR

Capacity

You must make sure your generator can supply enough rated (running) and surge (starting) watts for the items you will power at the same time. Follow these simple steps:

1. Select the items you will power at the same time.
2. Total the rated (running) watts of these items. This is the amount of power your generator must produce to keep your items running. See Figure 11.
3. Estimate how many surge (starting) watts you will need. Surge wattage is the short burst of power needed to start electric motor-driven tools or appliances such as a circular saw or refrigerator. Because not all motors start at the same time, total surge watts can be estimated by adding only the item(s) with the highest additional surge watts to the total rated watts from step 2.

Example:

Tool or Appliance	Rated (Running) Watts	Additional Surge (Starting) Watts
Window Air Conditioner	1200	1800
Refrigerator	800	1600
Deep Freezer	500	500
Television	500	-
Light (75 Watts)	75	-
	3075 Total Running Watts	1800 Highest Surge Watts

Total Rated (Running) Watts = 3075
 Highest Additional Surge Watts = 1800
 Total Generator Output Required = 4875

Power Management

To prolong the life of your generator and attached devices, it is important to take care when adding electrical loads to your generator. There should be nothing connected to the generator outlets before starting its engine. The correct and safe way to manage generator power is to sequentially add loads as follows:

1. With nothing connected to the generator, start the engine as described in this manual.
2. Plug in and turn on the first load, preferably the largest load you have.
3. Permit the generator output to stabilize (engine runs smoothly and attached device operates properly).

4. Plug in and turn on the next load.
5. Again, permit the generator to stabilize.
6. Repeat steps 4 and 5 for each additional load.

NEVER add more loads than the generator capacity. Take special care to consider surge loads in generator capacity, as described above.

Figure 11 - Wattage Reference Chart

Tool or Appliance	Rated* (Running) Watts	Additional Surge (Starting) Watts
Essentials		
Light Bulb - 75 watt	75	-
Deep Freezer	500	500
Sump Pump	800	1200
Refrigerator/Freezer - 18 Cu. Ft.	800	1600
Water Well Pump - 1/3 HP	1000	2000
Heating/Cooling		
Window AC - 10,000 BTU	1200	1800
Window Fan	300	600
Furnace Fan Blower - 1/2 HP	800	1300
Kitchen		
Microwave Oven - 1000 Watt	1000	-
Coffee Maker	1500	-
Electric Stove - Single Element	1500	-
Hot Plate	2500	-
Family Room		
DVD/CD Player	100	-
VCR	100	-
Stereo Receiver	450	-
Color Television - 27"	500	-
Personal Computer w/17" monitor	800	-
Other		
Security System	180	-
AM/FM Clock Radio	300	-
Garage Door Opener - 1/2 HP	480	520
Electric Water Heater - 40 Gallon	4000	-
DIY/Job Site		
Quartz Halogen Work Light	1000	-
Airless Sprayer - 1/3 HP	600	1200
Reciprocating Saw	960	960
Electric Drill - 1/2 HP	1000	1000
Circular Saw - 7 1/4"	1500	1500
Miter Saw - 10"	1800	1800
Planer/Joiner - 6"	1800	1800
Table Saw/Radial Arm Saw - 10"	2000	2000
Air Compressor - 1-1/2 HP	2500	2500

*Wattages listed are approximate only. Check tool or appliance for actual wattage.



WheelHouse™ 5550 Watt Generator



SPECIFICATIONS

- Maximum Surge Watts8,550 watts
- Continuous Wattage Capacity5,550 watts
- Power Factor1.0
- Rated Maximum Continuous AC Load Current:
 - At 120 Volts46.2 Amps
 - At 240 Volts23.1 Amps
- Phase1-phase
- Rated Frequency60 Hertz
- Fuel Tank Capacity5 U.S. gallons
- Shipping Weight176 lbs.

GENERAL MAINTENANCE RECOMMENDATIONS

The Owner/Operator is responsible for making sure that all periodic maintenance tasks are completed on a timely basis; that all discrepancies are corrected; and that the unit is kept clean and properly stored. **NEVER operate a damaged or defective generator.**

NOTE: Should you have questions about replacing components on your Generac Portable Products generator, please call **1-800-270-1408** for assistance.

Engine Maintenance

See engine owner's manual for instructions.

CAUTION

Avoid prolonged or repeated skin contact with used motor oil.

- Used motor oil has been shown to cause skin cancer in certain laboratory animals.
- Thoroughly wash exposed areas with soap and water.



KEEP OUT OF REACH OF CHILDREN. DON'T POLLUTE. CONSERVE RESOURCES. RETURN USED OIL TO COLLECTION CENTERS.

Generator Maintenance

Generator maintenance consists of keeping the unit clean and dry. Operate and store the unit in a clean dry environment where it will not be exposed to excessive dust, dirt, moisture or any corrosive vapors. Cooling air slots in the generator must not become clogged with snow, leaves or any other foreign material.

NOTE: DO NOT use a garden hose to clean generator. Water can enter engine fuel system and cause problems. In addition, if water enters generator through cooling air slots, some of the water will be retained in voids and cracks of the rotor and stator winding insulation. Water and dirt buildup on the generator internal windings will eventually decrease the insulation resistance of these windings.

WARNING

Unintentional sparking can result in fire or electric shock.

WHEN ADJUSTING OR MAKING REPAIRS TO YOUR GENERATOR

- Disconnect the spark plug wire from the spark plug and place the wire where it cannot contact spark plug.

WHEN TESTING FOR ENGINE SPARK

- Use approved spark plug tester.
- DO NOT check for spark with spark plug removed.

To Clean the Generator

- Use a damp cloth to wipe exterior surfaces clean.

CAUTION

Improper treatment of generator can damage it and shorten its life.

- DO NOT expose generator to excessive moisture, dust, dirt, or corrosive vapors.
- DO NOT insert any objects through cooling slots.

- Use a soft bristle brush to loosen caked on dirt or oil.
- Use a vacuum cleaner to pick up loose dirt and debris.
- Use low pressure air (not to exceed 25 psi) to blow away dirt. Inspect cooling air slots and opening on generator. These openings must be kept clean and unobstructed.



STORAGE

The generator should be started at least once every seven days and allowed to run at least 30 minutes. If this cannot be done and you must store the unit for more than 30 days, use the following guidelines to prepare it for storage.

Generator Storage

- Clean the generator as outlined in “To Clean the Generator.”
- Check that cooling air slots and openings on generator are open and unobstructed.



WARNING

Storage covers can be flammable.

- DO NOT place a storage cover over a hot generator.
- Let equipment cool for a sufficient time before placing the cover on the equipment.

Engine Storage

See engine owner’s manual for instructions.

Other Storage Tips

- Always store unit with fuel shut off valve in the “Off” position (Figure 4, earlier).
- To prevent gum from forming in fuel system or on essential carburetor parts, empty entire contents of both supplied fuel stabilizer containers into fuel tank and fill with fresh fuel. Run the unit for several minutes to circulate the additive through the carburetor. The unit and fuel can then be stored for up to 24 months. Additional fuel stabilizer can be purchased locally.
- Fuel tank may swell in storage if vent is closed. When storing generator with fuel in the tank, make sure the vent knob is turned fully counter-clockwise.
- Store unit in clean and dry area.



TROUBLESHOOTING

Problem	Cause	Solution
Engine is running, but no AC output is available.	<ol style="list-style-type: none"> 1. Circuit breaker is open. 2. Poor connection or defective cord set. 3. Connected device is bad. 4. Fault in generator. 	<ol style="list-style-type: none"> 1. Reset circuit breaker. 2. Check and repair. 3. Connect another device that is in good condition. 4. Contact local service facility.
Engine runs good but bogs down when loads are connected.	<ol style="list-style-type: none"> 1. Short circuit in a connected load. 2. Generator is overloaded. 3. Shorted generator circuit. 	<ol style="list-style-type: none"> 1. Disconnect shorted electrical load. 2. See "Don't Overload Generator". 3. Contact local service facility.
Engine will not start; or starts and runs rough.	<ol style="list-style-type: none"> 1. Fuel valve is in the "Off" position. 2. Vent knob in fuel gauge is closed. 3. Quick connect in fuel line is disconnected. 4. Out of gasoline. 	<ol style="list-style-type: none"> 1. Turn fuel valve to the "On" position. 2. Open vent knob in fuel gauge. 3. Reconnect quick connect in fuel line. 4. Fill fuel tank.
Engine shuts down during operation.	Out of gasoline.	Fill fuel tank.
Engine lacks power.	Load is too high.	See "Don't Overload Generator".

<http://allthumbsdiy.com/outdoor-power-equipment/fast-and-easy-fix-for-your-generac-wheelhouse-5500-5550-portable-generator>

NOTES

WheelHouse™ 5550 Watt Generator



NOTES

GENERAC PORTABLE PRODUCTS OWNER EQUIPMENT WARRANTY POLICY
Effective November 1, 2004

LIMITED WARRANTY

"Generac Portable Products is a licensed trademark of Briggs & Stratton Power Products. Briggs & Stratton Power Products will repair or replace, free of charge, any part, or parts of the equipment** that are defective in material or workmanship or both. Transportation charges on parts submitted for repair or replacement under this warranty must be borne by purchaser. This warranty is effective for the time periods and subject to the conditions provided for in this policy. For warranty service, find your nearest Authorized service dealer by calling 1-800-270-1408. Warranty service may only be performed by a Briggs & Stratton Power Products Authorized service dealer.

THERE IS NO OTHER EXPRESS WARRANTY. IMPLIED WARRANTIES, INCLUDING THOSE OF MERCHANTABILITY AND FITNESS FOR A PARTICULAR PURPOSE, ARE LIMITED TO THE TIME PERIOD SPECIFIED, OR TO THE EXTENT PERMITTED BY LAW. ANY AND ALL IMPLIED WARRANTIES ARE EXCLUDED. LIABILITY FOR CONSEQUENTIAL DAMAGES UNDER ANY AND ALL WARRANTIES ARE EXCLUDED TO THE EXTENT EXCLUSION IS PERMITTED BY LAW. Some countries or states do not allow limitations on how long an implied warranty lasts, and some countries or states do not allow the exclusion or limitation of incidental or consequential damages, so the above limitation and exclusion may not apply to you. This warranty gives you specific legal rights and you may also have other rights that vary from country to country or state to state."

WARRANTY PERIOD*

PRODUCTS**	CONSUMER USE	COMMERCIAL USE
Pressure Washer	1 year	90 days
Portable Generator	2 years (2nd year parts only)	1 year

*The warranty period begins on the date of purchase by the first retail consumer or commercial end user, and continues for the period of time stated in the table above. "Consumer use" means personal residential household use by a retail consumer.

"Commercial use" means all other uses, including use for commercial, income producing or rental purposes. Once equipment has been used commercially, it shall thereafter be considered to be in commercial use for purposes of this warranty.

**The engine and starting batteries are warranted solely by the manufacturers of those products.

WARRANTY REGISTRATION IS NOT NECESSARY TO OBTAIN WARRANTY ON BRIGGS & STRATTON POWER PRODUCTS EQUIPMENT. SAVE YOUR PROOF OF PURCHASE RECEIPT. IF YOU DO NOT PROVIDE PROOF OF THE INITIAL PURCHASE DATE AT THE TIME WARRANTY SERVICE IS REQUESTED, THE MANUFACTURING DATE OF THE EQUIPMENT WILL BE USED TO DETERMINE THE WARRANTY PERIOD.

About your equipment warranty:

We welcome warranty repair and apologize to you for being inconvenienced. Any Authorized service dealer may perform warranty repairs. Most warranty repairs are handled routinely, but sometimes requests for warranty service may not be appropriate. For example, warranty service would not apply if equipment damage occurred because of misuse, lack of routine maintenance, shipping, handling, warehousing or improper installation. Similarly, the warranty is void if the manufacturing date or the serial number on the equipment has been removed or the equipment has been altered or modified. During the warranty period, the Authorized service dealer, at its option, will repair or replace any part that, upon examination, is found to be defective under normal use and service. This warranty will not cover following repairs and equipment:

Normal Wear: Outdoor power equipment, like all mechanical devices, needs periodic parts, service and replacement to perform well. This warranty does not cover repair when normal use has exhausted the life of a part or the equipment.

Installation and Maintenance: This warranty does not apply to equipment or parts that have been subjected to improper or unauthorized installation or alteration and modification, misuse, negligence, accident, overloading, overspeeding, improper maintenance, repair or storage so as, in our judgment, to adversely affect its performance and reliability. This warranty also does not cover normal maintenance such as adjustments, fuel system cleaning and obstruction (due to chemical, dirt, carbon or lime, etc.).

Other Exclusions: Also excluded from this warranty are wear items such as quick couplers, oil gauges, belts, o-rings, filters, pump packing, etc., pumps which have been run without water supplied or damage or malfunctions resulting from accidents, abuse, modifications, alterations, or improper servicing or freezing or chemical deterioration. Accessory parts such as guns, hoses, wands and nozzles are excluded from the product warranty. This warranty excludes failures due to acts of God and other force majeure events beyond the manufacturers control. Also excluded is used, reconditioned, and demonstration equipment; equipment used for prime power in place of utility power and equipment used in life support applications.

BRIGGS & STRATTON POWER PRODUCTS GROUP, LLC

JEFFERSON, WISCONSIN, U.S.A.

http://allthumbsdiy.com/outdoor-power-equipment/fast-and-easy-fix-for-your-generac-wheelhouse-5500-5550-portable-generator